

## Rail Grade DC-DC Power Supply

<b>66-160 V</b> Continuous Input	<b>200V</b> Transient Input	<b>5.0-48V</b> Outputs	<b>100W</b> Max Power	<b>2000Vrms</b> 60s per EN 50155	<b>Quarter-brick</b> DC-DC Converter
-------------------------------------	--------------------------------	---------------------------	--------------------------	-------------------------------------	---



The RailQor® quarter-brick converter series is composed of next-generation, board-mountable, isolated (**REINFORCED**), fixed switching frequency dc-dc converters that use synchronous rectification to achieve extremely high power conversion efficiency, even at low output power levels. Each module is supplied completely encased to provide protection from the harsh environments seen in many industrial and transportation applications.

### Protection Features

- ▶ Input under-voltage lockout
- ▶ Output current limit and short circuit protection
- ▶ Active back bias limit
- ▶ Output over-voltage protection
- ▶ Thermal shutdown

### Control Features

- ▶ On/Off control referenced to input side
- ▶ Remote sense for the output voltage
- ▶ Output voltage trim range of -20%, +10%

### Operational Features

- ▶ High efficiency, 92% at full rated load current
- ▶ Delivers full power with conductive cooling
- ▶ Operating input voltage range: 66-160 V
- ▶ Fixed frequency switching provides predictable EMI
- ▶ No minimum load requirement
- ▶ Meets requirements of standard EN 50155

### Mechanical Features

- ▶ Industry standard Quarter-brick pin-out configuration
- ▶ Size: 2.386" x 1.536" x 0.500" (60.60 x 39.01 x 12.70 mm)
- ▶ Weight: 2.9 oz. (84 g)
- ▶ Flanged baseplate version available

### Safety Features

#### Reinforced Insulation

- ▶ Input-to-output isolation 2000Vrms
- ▶ UL 60950-1
- ▶ CAN/CSA C22.2 No. 60950-1
- ▶ EN 60950-1
- ▶ EN45545-2 R24/R25 Compliant
- ▶ CE Marked
- ▶ RoHS compliant (see last page)

### Contents

Family Electrical Characteristics .....	2
Electrical Characteristics (5Vout) & Figures .....	4
Electrical Characteristics (12Vout) & Figures .....	6
Electrical Characteristics (24Vout) & Figures .....	8
Electrical Characteristics (48Vout) & Figures .....	10
Application Section.....	12
Standard Mechanical Diagram.....	17
Flanged Mechanical Diagram.....	18
Standards & Qualification Testing .....	19
Ordering Information .....	20

## RQ1B Family Electrical Characteristics (all output voltages)

Ta = 25 °C, airflow rate = 300 LFM, Vin = 110Vdc unless otherwise noted; full operating temperature range is -40 °C to +100 °C baseplate temperature with appropriate power derating. Specifications subject to change without notice.

Parameter	Min.	Typ.	Max.	Units	Notes & Conditions
<b>ABSOLUTE MAXIMUM RATINGS</b>					
Input Voltage					
Non-Operating	-1		200	V	Continuous
Operating			160	V	Continuous
Operating Transient Protection			200	V	1 s
Isolation Voltage					Reinforced insulation, IEC 60950-1
Input to Output			2000	Vrms	60 s per EN 50155
Input to Baseplate			2000	Vrms	60 s per EN 50155
Output to Baseplate			500	Vrms	60 s per EN 50155
Operating Temperature	-40		100	°C	Baseplate temperature
Storage Temperature	-45		125	°C	
Voltage at ON/OFF input pin	-2		18	V	
<b>INPUT CHARACTERISTICS</b>					
Operating Input Voltage Range	66	110	160	V	
Input Under-Voltage Lockout					
Turn-On Voltage Threshold	61.1	63.7	66.2	V	
Turn-Off Voltage Threshold	57.7	60.3	62.9	V	
Lockout Voltage Hysteresis		3.4		V	
Recommended External Input Capacitance		100		µF	Typical ESR 0.1-0.2 Ω; see Note 2
Input Filter Component Values (L\C)		15\1.1		µH\µF	Internal values; see Figure D
<b>DYNAMIC CHARACTERISTICS</b>					
Turn-On Transient					
Turn-On Time		9		ms	Full load, Vout=90% nom.
Start-Up Inhibit Time	180	200	220	ms	See Figure E
Output Voltage Overshoot		0		%	Maximum Output Capacitance
<b>ISOLATION CHARACTERISTICS</b>					
Isolation Voltage (dielectric strength)					See Absolute Maximum Ratings
Insulation Resistance	100			MΩ	Tested at 500 Vdc per EN 50155
Isolation Capacitance (input to output)		1000		pF	See Note 1
<b>TEMPERATURE LIMITS FOR POWER DERATING CURVES</b>					
Semiconductor Junction Temperature			125	°C	Package rated to 150 °C
Board Temperature			125	°C	UL rated max operating temp 130 °C
Transformer Temperature			125	°C	
Maximum Baseplate Temperature, Tb			100	°C	
<b>FEATURE CHARACTERISTICS</b>					
Switching Frequency	230	250	270	kHz	Isolation stage switching freq. is the same
ON/OFF Control					
Off-State Voltage	2.4		18	V	
On-State Voltage	-2		0.8	V	
ON/OFF Control					Application notes Figures A & B
Pull-Up Voltage		5		V	
Pull-Up Resistance		50		kΩ	
Over-Temperature Shutdown OTP Trip Point		125		°C	Average PCB Temperature
Over-Temperature Shutdown Restart Hysteresis		10		°C	
<b>RELIABILITY CHARACTERISTICS</b>					
Calculated MTBF (MIL-217) MIL-HDBK-217F		1.31		10 <sup>6</sup> Hrs.	Tb = 70°C
Field Demonstrated MTBF				10 <sup>6</sup> Hrs.	See our website for details

Note 1: Higher values of isolation capacitance can be added external to the module.

Note 2: See "Input System Instability" in the Application Considerations section

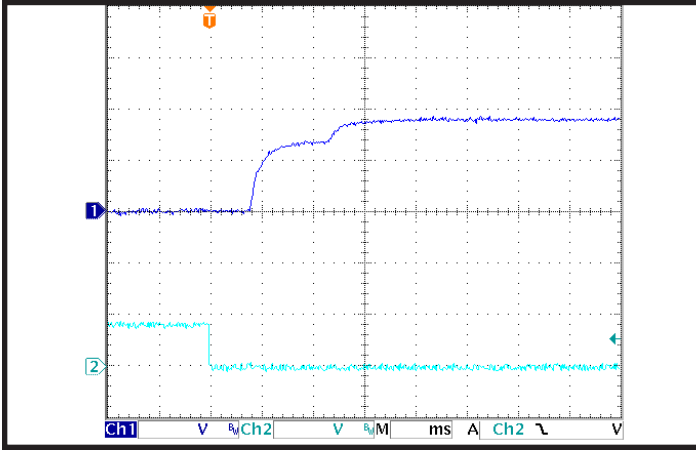

Common Figure 1: Typical startup waveform. Input voltage pre-applied, ON/OFF Pin on Ch 2.

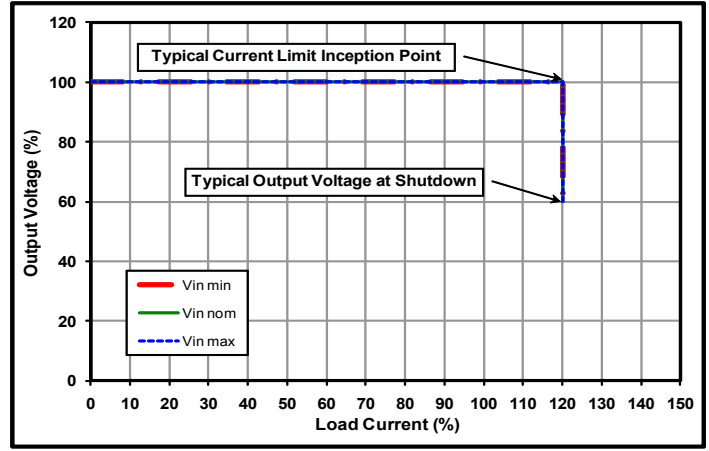

Common Figure 2: Output voltage vs. load current showing typical current limit curves and converter shutdown points.

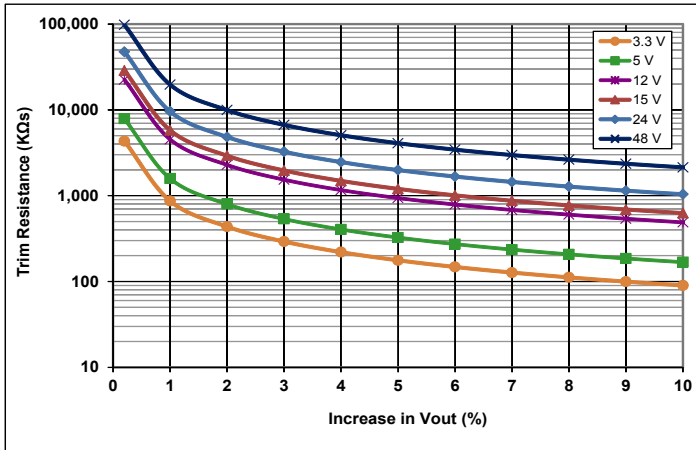

Common Figure 3: Trim graph for trim-up 3.3 to 48V outputs.

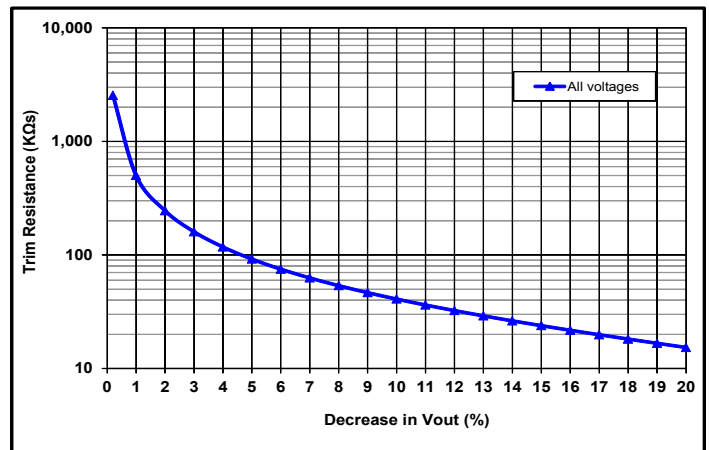

Common Figure 4: Trim graph for trim down.

## RQ1B050QGx20 Electrical Characteristics(5.0 Vout)

Ta = 25 °C, airflow rate = 300 LFM, Vin = 110Vdc unless otherwise noted; full operating temperature range is -40 °C to +100 °C baseplate temperature with appropriate power derating. Specifications subject to change without notice.

Parameter	Min.	Typ.	Max.	Units	Notes & Conditions
<b>INPUT CHARACTERISTICS</b>					
Maximum Input Current			2.2	A	Vin min; trim up; in current limit
No-Load Input Current		30	40	mA	
Disabled Input Current		2.5		mA	
Response to Input Transient		0.08		V	See Figure 6
Input Terminal Ripple Current		70		mA	RMS
Recommended Input Fuse			5	A	Fast acting fuse recommended; see Note 2
<b>OUTPUT CHARACTERISTICS</b>					
Output Voltage Set Point	4.950	5.000	5.050	V	
Output Voltage Regulation					
Over Line		±0.1	±0.3	%	
Over Load		±0.1	±0.3	%	
Over Temperature	-75		75	mV	
Total Output Voltage Range	4.875		5.125	V	Over sample, line, load, temperature & life
Output Voltage Ripple and Noise					20 MHz bandwidth; see Note 1
Peak-to-Peak	0	80	180	mV	Full load
RMS		15	30	mV	Full load
Operating Output Current Range	0		20	A	Subject to thermal derating
Output DC Current-Limit Inception	22.0	24.0	26.0	A	Output voltage 10% Low
Output DC Current-Limit Shutdown Voltage		2.7		V	
Back-Drive Current Limit while Enabled		0.6		A	Negative current drawn from output
Back-Drive Current Limit while Disabled		15		mA	Negative current drawn from output
Maximum Output Capacitance			8,000	µF	Vout nominal at full load (resistive load)
Output Voltage during Load Current Transient					
Step Change in Output Current (0.1 A/µs)		100		mV	50% to 75% to 50% Iout max
Settling Time		160		µs	To within 1% Vout nom
Output Voltage Trim Range	-20		10	%	Across Pins 8&4; Common Figures 3-5
Output Voltage Remote Sense Range			10	%	Across Pins 8&4
Output Over-Voltage Protection	5.9	6.1	6.4	V	Over full temp range
<b>EFFICIENCY</b>					
100% Load		90		%	See Figure 1 for efficiency curve
50% Load		91		%	See Figure 1 for efficiency curve

Note 1: Output is terminated with 1 µF ceramic and 15 µF low-ESR tantalum capacitors. For applications requiring reduced output voltage ripple and noise, consult SynQor applications support (e-mail: support@synqor.com)

Note 2: Safety certification requires the use of a fuse rated at or below this value.

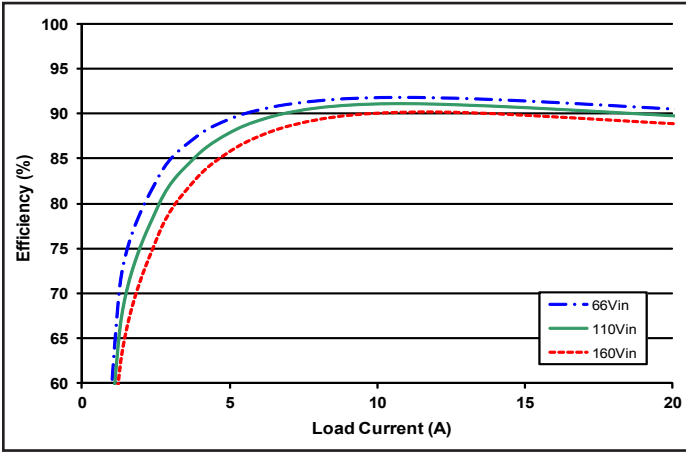

Figure 1: Efficiency at nominal output voltage vs. load current for minimum, nominal, and maximum input voltages at 25°C.

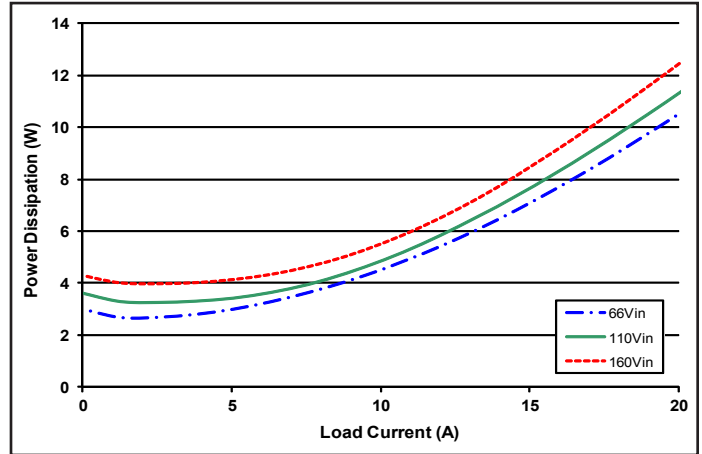

Figure 2: Power dissipation at nominal output voltage vs. load current for minimum, nominal, and maximum input voltages at 25°C.

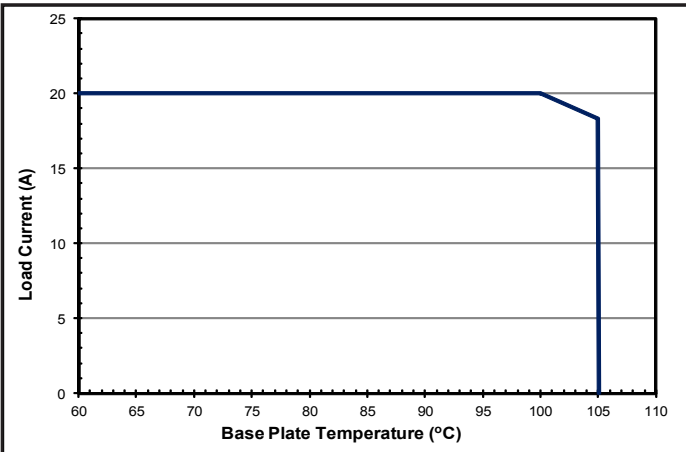

Figure 3: Encased Converter (with conductive cooling) maximum output power derating vs. base plate temperature (nominal input voltage).

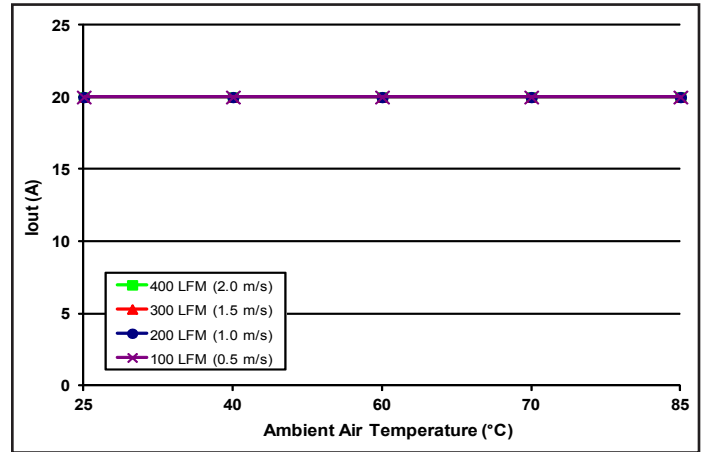

Figure 4: Encased Converter (1/2" heatsink) max. output current derating vs. ambient air temperature for airflow rates of 100 LFM through 400 LFM. Air flows across the converter from pin 3 to pin 1 (nominal input voltage).

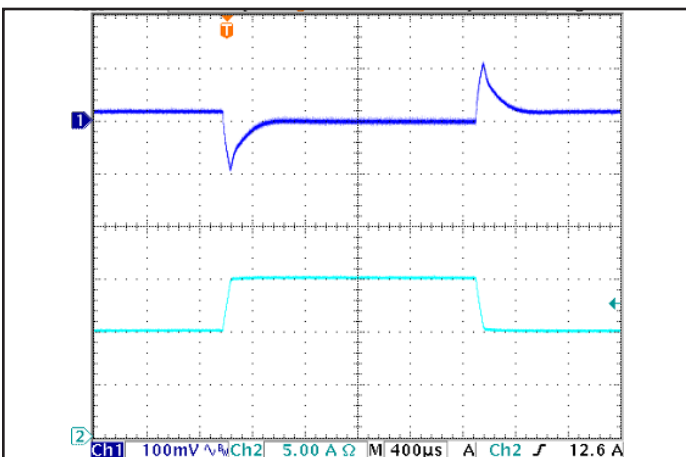

Figure 5: Output voltage response to step-change in load current (50%-75%-50% of I<sub>out</sub>(max); dI/dt = 0.1 A/μs). Load cap: 1 μF ceramic and 15 μF tantalum capacitors. Ch 1: V<sub>out</sub>, Ch 2: I<sub>out</sub> (5A/div)

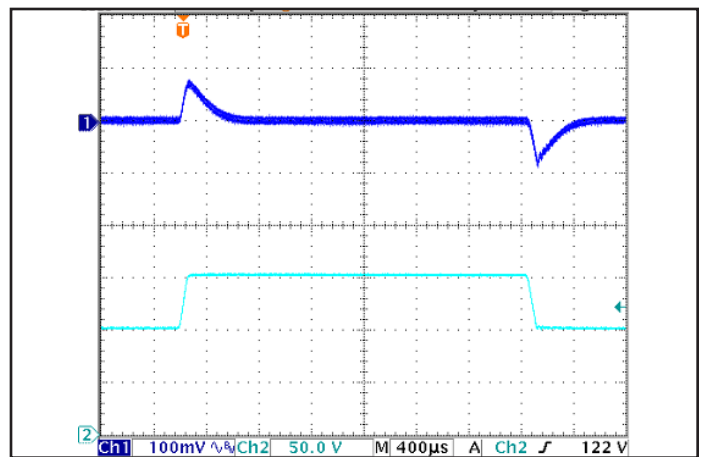

Figure 6: Output voltage response to step-change in input voltage (1V/μs). Load cap: 1 μF ceramic and 15 μF tantalum capacitors. Ch 1: V<sub>out</sub>, Ch 2: V<sub>in</sub>.

## RQ1B120QGx08 Electrical Characteristics(12.0 Vout)

Ta = 25 °C, airflow rate = 300 LFM, Vin = 110Vdc unless otherwise noted; full operating temperature range is -40 °C to +100 °C baseplate temperature with appropriate power derating. Specifications subject to change without notice.

Parameter	Min.	Typ.	Max.	Units	Notes & Conditions
<b>INPUT CHARACTERISTICS</b>					
Maximum Input Current			2.0	A	Vin min; Vout nom; in current limit
No-Load Input Current		43	50	mA	
Disabled Input Current		2.4		mA	
Response to Input Transient		0.1		V	See Figure 6
Input Terminal Ripple Current		100		mA	RMS
Recommended Input Fuse			5	A	Fast acting fuse recommended; see Note 2
<b>OUTPUT CHARACTERISTICS</b>					
Output Voltage Set Point	11.88	12.00	12.12	V	
Output Voltage Regulation					
Over Line		±0.1	±0.3	%	
Over Load		±0.1	±0.3	%	
Over Temperature	-180		180	mV	
Total Output Voltage Range	11.70		12.30	V	Over sample, line, load, temperature & life
Output Voltage Ripple and Noise					20 MHz bandwidth; see Note 1
Peak-to-Peak	0	65	130	mV	Full load
RMS		15	30	mV	Full load
Operating Output Current Range	0		8.4	A	Subject to thermal derating
Output DC Current-Limit Inception	9.2	10.1	10.9	A	Output voltage 10% Low
Output DC Current-Limit Shutdown Voltage		4.9		V	
Back-Drive Current Limit while Enabled		0.56		A	Negative current drawn from output
Back-Drive Current Limit while Disabled		15		mA	Negative current drawn from output
Maximum Output Capacitance			1,500	µF	Vout nominal at full load (resistive load)
Output Voltage during Load Current Transient					
Step Change in Output Current (0.1 A/µs)		340		mV	50% to 75% to 50% Iout max
Settling Time		80		µs	To within 1% Vout nom
Output Voltage Trim Range	-20		10	%	Across Pins 8&4; Common Figures 3-5
Output Voltage Remote Sense Range			10	%	Across Pins 8&4
Output Over-Voltage Protection	14.0	14.6	15.2	V	Over full temp range
<b>EFFICIENCY</b>					
100% Load		92		%	See Figure 1 for efficiency curve
50% Load		91		%	See Figure 1 for efficiency curve

Note 1: Output is terminated with 1 µF ceramic and 15 µF low-ESR tantalum capacitors. For applications requiring reduced output voltage ripple and noise, consult SynQor applications support (e-mail: support@synqor.com)

Note 2: Safety certification requires the use of a fuse rated at or below this value.

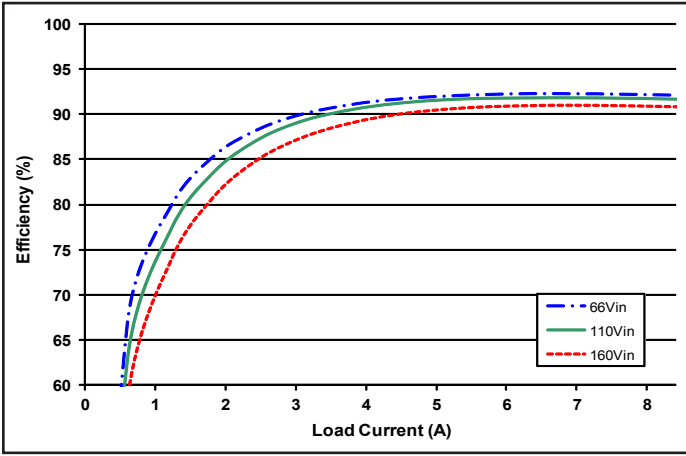

Figure 1: Efficiency at nominal output voltage vs. load current for minimum, nominal, and maximum input voltages at 25°C.

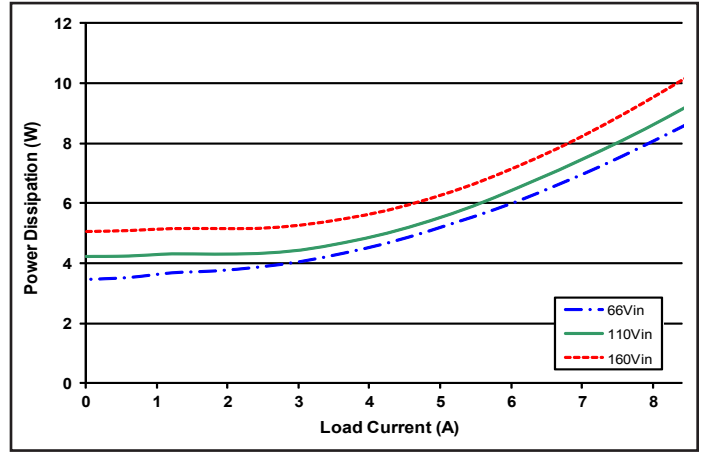

Figure 2: Power dissipation at nominal output voltage vs. load current for minimum, nominal, and maximum input voltages at 25°C.

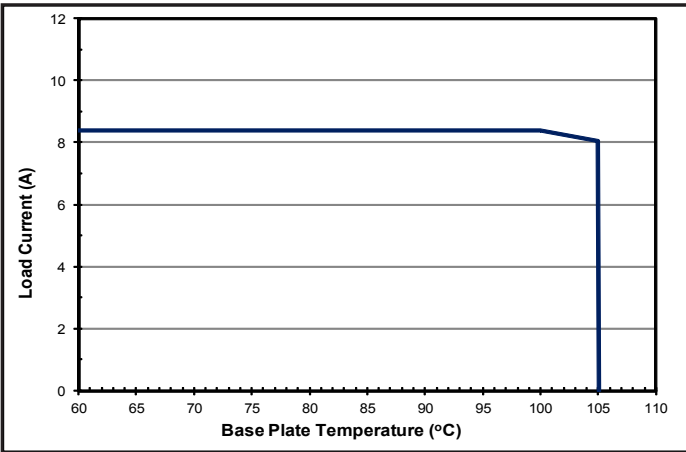

Figure 3: Encased Converter (with conductive cooling) maximum output power derating vs. base plate temperature (nominal input voltage).

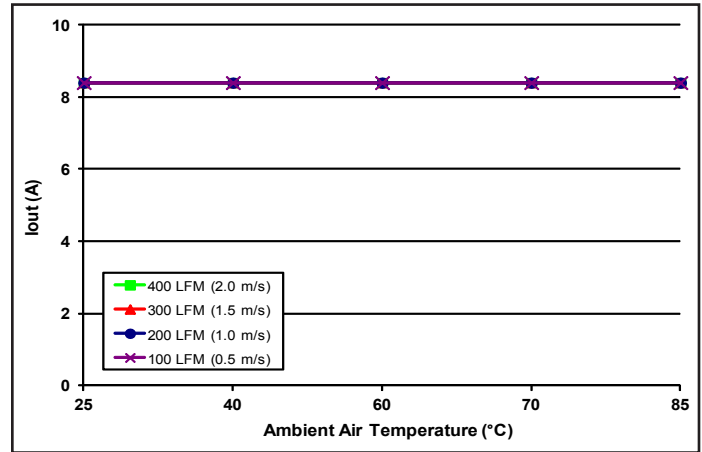

Figure 4: Encased Converter (1/2" heatsink) max. output current derating vs. ambient air temperature for airflow rates of 100 LFM through 400 LFM. Air flows across the converter from pin 3 to pin 1 (nominal input voltage).

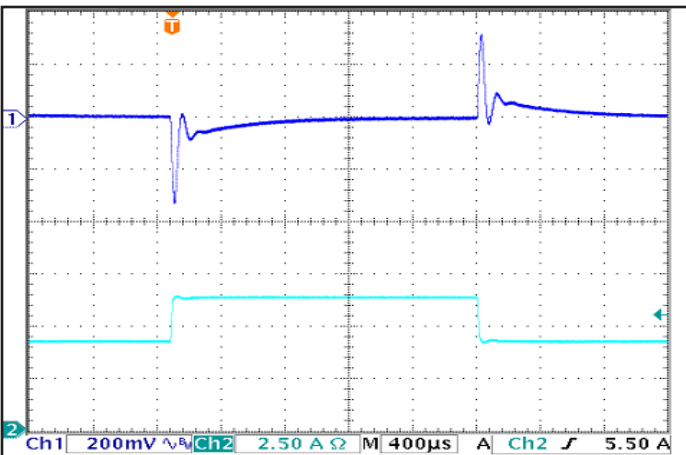

Figure 5: Output voltage response to step-change in load current (50%-75%-50% of Iout(max); di/dt = 0.1 A/μs). Load cap: 1 μF ceramic and 15 μF tantalum capacitors. Ch 1: Vout, Ch 2: Iout (2.5A/div)

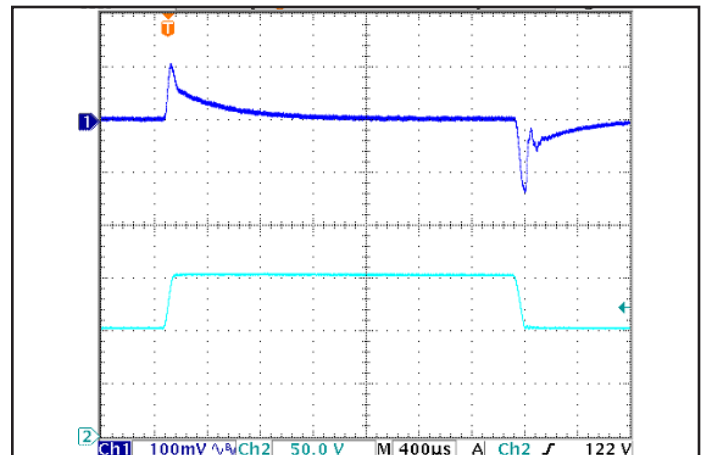

Figure 6: Output voltage response to step-change in input voltage (1V/μs). Load cap: 1 μF ceramic and 15 μF tantalum capacitors. Ch 1: Vout, Ch 2: Vin.

## RQ1B240QGx04 Electrical Characteristics(24.0 Vout)

Ta = 25 °C, airflow rate = 300 LFM, Vin = 110Vdc unless otherwise noted; full operating temperature range is -40 °C to +100 °C baseplate temperature with appropriate power derating. Specifications subject to change without notice.

Parameter	Min.	Typ.	Max.	Units	Notes & Conditions
<b>INPUT CHARACTERISTICS</b>					
Maximum Input Current			2.2	A	Vin min; trim up; in current limit
No-Load Input Current		50	60	mA	
Disabled Input Current		2.5		mA	
Response to Input Transient		0.5		V	See Figure 6
Input Terminal Ripple Current		100		mA	RMS
Recommended Input Fuse			5	A	Fast acting fuse recommended; see Note 2
<b>OUTPUT CHARACTERISTICS</b>					
Output Voltage Set Point	23.76	24.00	24.24	V	
Output Voltage Regulation					
Over Line		±0.1	±0.3	%	
Over Load		±0.1	±0.3	%	
Over Temperature	-360		360	mV	
Total Output Voltage Range	23.40		24.60	V	Over sample, line, load, temperature & life
Output Voltage Ripple and Noise					20 MHz bandwidth; see Note 1
Peak-to-Peak	0	200	400	mV	Full load
RMS		50	100	mV	Full load
Operating Output Current Range	0		4.2	A	Subject to thermal derating
Output DC Current-Limit Inception	4.6	5.0	5.5	A	Output voltage 10% Low
Output DC Current-Limit Shutdown Voltage		12		V	
Back-Drive Current Limit while Enabled		0.5		A	Negative current drawn from output
Back-Drive Current Limit while Disabled		15		mA	Negative current drawn from output
Maximum Output Capacitance			400	µF	Vout nominal at full load (resistive load)
Output Voltage during Load Current Transient					
Step Change in Output Current (0.1 A/µs)		600		mV	50% to 75% to 50% Iout max
Settling Time		100		µs	To within 1% Vout nom
Output Voltage Trim Range	-20		10	%	Across Pins 8&4; Common Figures 3-5
Output Voltage Remote Sense Range			10	%	Across Pins 8&4
Output Over-Voltage Protection	28.1	29.3	30.5	V	Over full temp range
<b>EFFICIENCY</b>					
100% Load		91		%	See Figure 1 for efficiency curve
50% Load		90		%	See Figure 1 for efficiency curve

Note 1: Output is terminated with 1 µF ceramic and 15 µF low-ESR tantalum capacitors. For applications requiring reduced output voltage ripple and noise, consult SynQor applications support (e-mail: support@synqor.com)

Note 2: Safety certification requires the use of a fuse rated at or below this value.



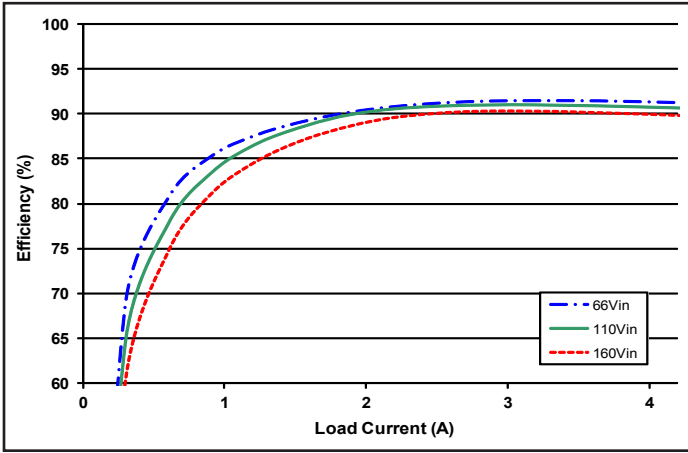

Figure 1: Efficiency at nominal output voltage vs. load current for minimum, nominal, and maximum input voltages at 25°C.

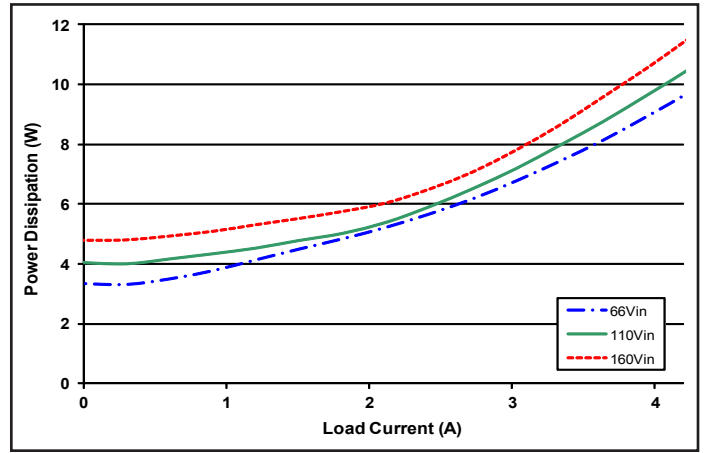

Figure 2: Power dissipation at nominal output voltage vs. load current for minimum, nominal, and maximum input voltages at 25°C.

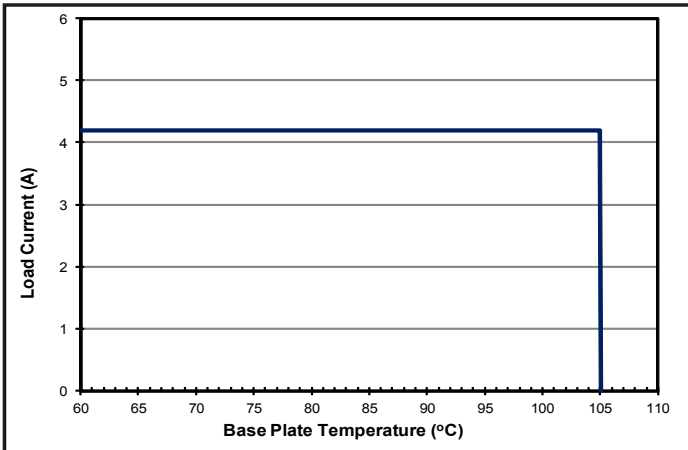

Figure 3: Encased Converter (with conductive cooling) maximum output power derating vs. base plate temperature (nominal input voltage).

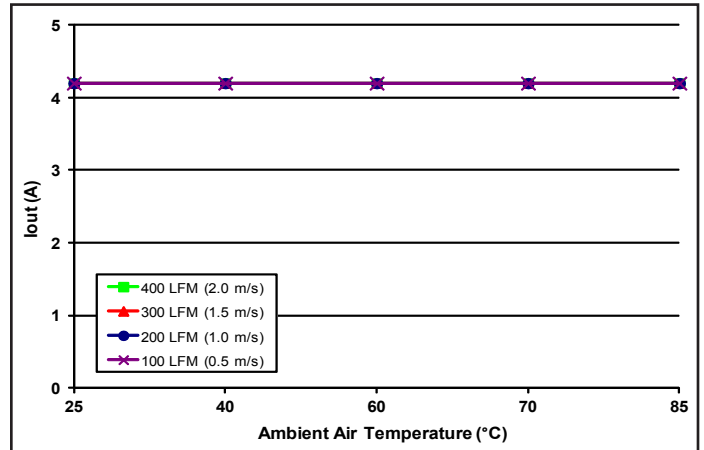

Figure 4: Encased Converter (1/2" heatsink) max. output current derating vs. ambient air temperature for airflow rates of 100 LFM through 400 LFM. Air flows across the converter from pin 3 to pin 1 (nominal input voltage).

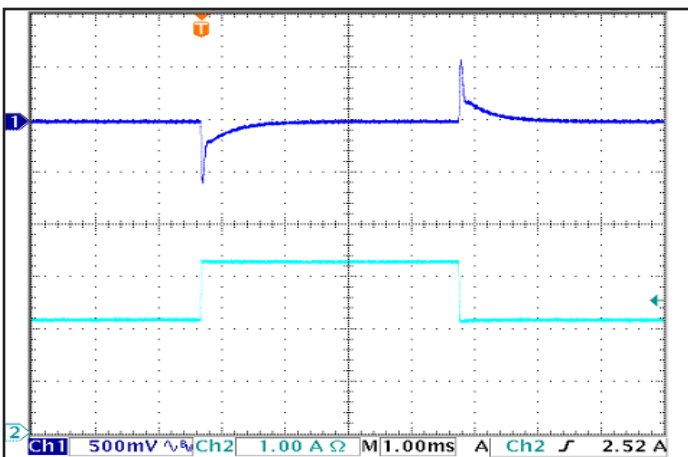

Figure 5: Output voltage response to step-change in load current (50%-75%-50% of I<sub>out</sub>(max); dI/dt = 0.1 A/μs). Load cap: 1 μF ceramic capacitor. Ch 1: V<sub>out</sub>, Ch 2: I<sub>out</sub> (1A/div).

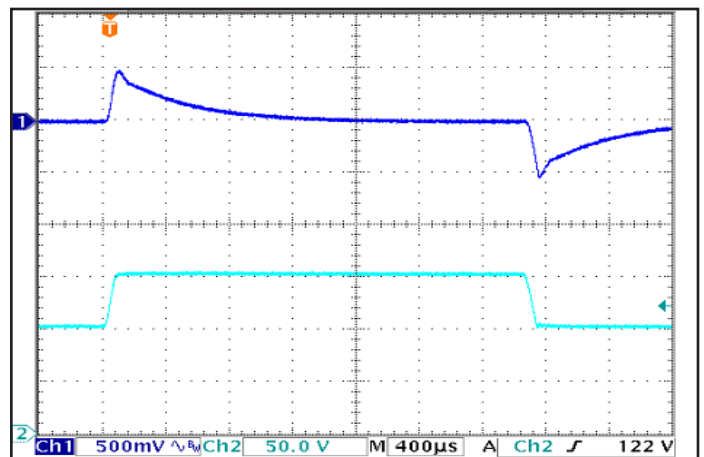

Figure 6: Output voltage response to step-change in input voltage (1V/ms). Load cap: 1 μF ceramic capacitor. Ch 1: V<sub>out</sub>, Ch 2: V<sub>in</sub>.

## RQ1B480QGx02 Electrical Characteristics(48.0 Vout)

Ta = 25 °C, airflow rate = 300 LFM, Vin = 110Vdc unless otherwise noted; full operating temperature range is -40 °C to +100 °C baseplate temperature with appropriate power derating. Specifications subject to change without notice.

Parameter	Min.	Typ.	Max.	Units	Notes & Conditions
<b>INPUT CHARACTERISTICS</b>					
Maximum Input Current			2.2	A	Vin min; trim up; in current limit
No-Load Input Current		45	60	mA	
Disabled Input Current		2		mA	
Response to Input Transient		0.45		V	See Figure 6
Input Terminal Ripple Current		80		mA	RMS
Recommended Input Fuse			5	A	Fast acting fuse recommended; see Note 2
<b>OUTPUT CHARACTERISTICS</b>					
Output Voltage Set Point	47.52	48.00	48.48	V	
Output Voltage Regulation					
Over Line		±0.1	±0.3	%	
Over Load		±0.1	±0.3	%	
Over Temperature	-720		720	mV	
Total Output Voltage Range	46.80		49.20	V	Over sample, line, load, temperature & life
Output Voltage Ripple and Noise					20 MHz bandwidth; see Note 1
Peak-to-Peak		240	480	mV	Full load
RMS		50	100	mV	Full load
Operating Output Current Range	0		2.1	A	Subject to thermal derating
Output DC Current-Limit Inception	2.3	2.5	2.7	A	Output voltage 10% Low
Output DC Current-Limit Shutdown Voltage		21		V	
Back-Drive Current Limit while Enabled		0.21		A	Negative current drawn from output
Back-Drive Current Limit while Disabled		15		mA	Negative current drawn from output
Maximum Output Capacitance			100	µF	Vout nominal at full load (resistive load)
Output Voltage during Load Current Transient					
Step Change in Output Current (0.1 A/µs)		1000		mV	50% to 75% to 50% Iout max
Settling Time		100		µs	To within 1% Vout nom
Output Voltage Trim Range	-20		10	%	Across Pins 8&4; Common Figures 3-5
Output Voltage Remote Sense Range			10	%	Across Pins 8&4
Output Over-Voltage Protection	56.2	58.6	61.0	V	Over full temp range
<b>EFFICIENCY</b>					
100% Load		90		%	See Figure 1 for efficiency curve
50% Load		88		%	See Figure 1 for efficiency curve

Note 1: Output is terminated with 1 µF ceramic and 15 µF low-ESR tantalum capacitors. For applications requiring reduced output voltage ripple and noise, consult SynQor applications support (e-mail: support@synqor.com)

Note 2: Safety certification requires the use of a fuse rated at or below this value.

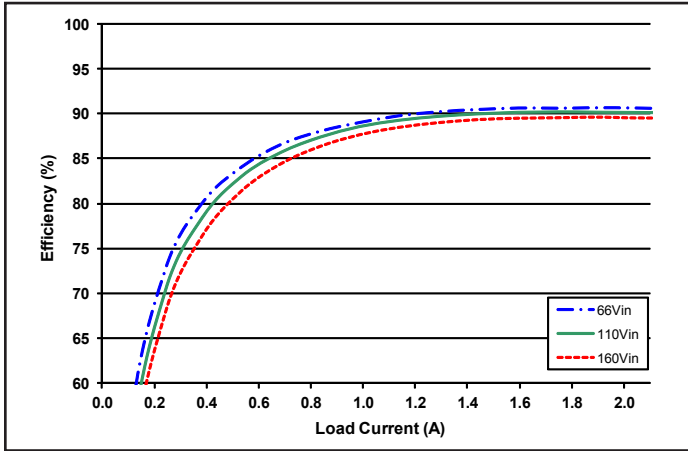

Figure 1: Efficiency at nominal output voltage vs. load current for minimum, nominal, and maximum input voltages at 25°C.

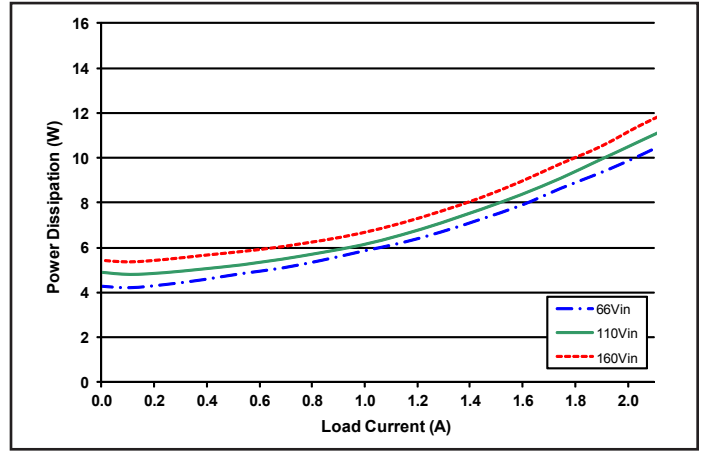

Figure 2: Power dissipation at nominal output voltage vs. load current for minimum, nominal, and maximum input voltages at 25°C.

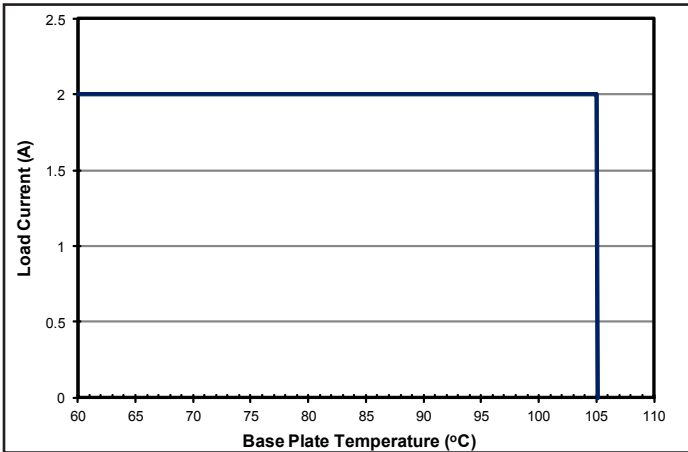

Figure 3: Encased Converter (with conductive cooling) maximum output power derating vs. base plate temperature (nominal input voltage).

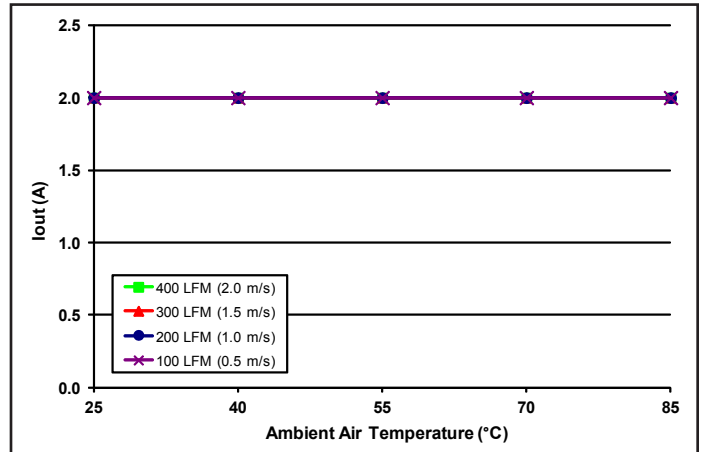

Figure 4: Encased Converter (1/2" heatsink) max. output current derating vs. ambient air temperature for airflow rates of 100 LFM through 400 LFM. Air flows across the converter from pin 3 to pin 1 (nominal input voltage).

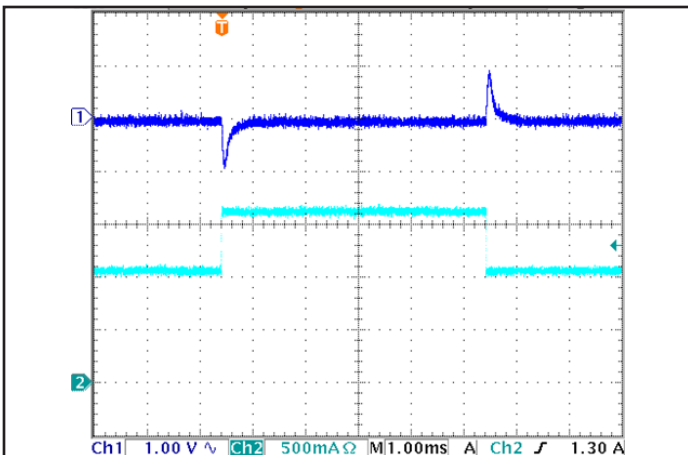

Figure 5: Output voltage response to step-change in load current (50%-75%-50% of  $I_{out(max)}$ ;  $dI/dt = 0.1 A/\mu s$ ). Load cap:  $1 \mu F$  ceramic capacitor. Ch 1:  $V_{out}$ , Ch 2:  $I_{out}$  (500mA/div)

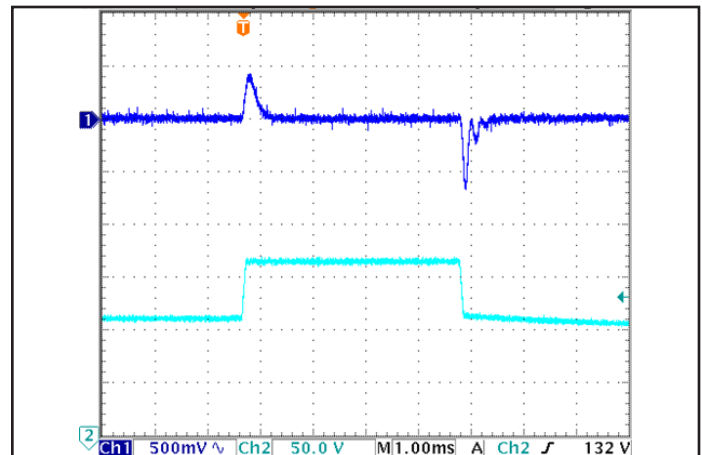

Figure 6: Output voltage response to step-change in input voltage (1V/ms). Load cap:  $1 \mu F$  ceramic capacitor. Ch 1:  $V_{out}$ , Ch 2:  $V_{in}$ .

## BASIC OPERATION AND FEATURES

This converter series uses a two-stage power conversion topology. The first stage is a buck-converter that keeps the output voltage constant over variations in line, load, and temperature. The second stage uses a transformer to provide the functions of input/output isolation and voltage step-up or step-down to achieve the output voltage required.

Both the first stage and the second stage switch at a fixed frequency for predictable EMI performance. Rectification of the transformer's output is accomplished with synchronous rectifiers. These devices, which are MOSFETs with a very low on-state resistance, dissipate far less energy than Schottky diodes. This is the primary reason that the converter has such high efficiency, even at very low output voltages and very high output currents.

These converters are offered totally encased to withstand harsh environments and thermally demanding applications. Conductive cooling design can be used with heat sink or cold plate cooling systems. Full power is available with baseplate temperature up to 100°C.

This series of converters use the industry standard footprint and pin-out configuration.

## CONTROL FEATURES

**REMOTE ON/OFF (Pin 2):** The ON/OFF input, Pin 2, permits the user to control when the converter is on or off. This input is referenced to the return terminal of the input bus, Vin(-).

The ON/OFF signal is active low (meaning that a low voltage turns the converter on). Figure A details four possible circuits for driving the ON/OFF pin.

**REMOTE SENSE(±) (Pins 7 and 5):** The SENSE(±) inputs correct for voltage drops along the conductors that connect the converter's output pins to the load.

Pin 7 should be connected to Vout(+) and Pin 5 should be connected to Vout(-) at the point on the board where regulation is desired. A remote connection at the load can adjust for a voltage drop only as large as that specified in this datasheet, that is

$$[V_{out(+)} - V_{out(-)}] - [V_{sense(+)} - V_{sense(-)}] < \text{Sense Range \%} \times V_{out}$$

Pins 7 and 5 must be connected for proper regulation of the output voltage. If these connections are not made, the converter will deliver an output voltage that is slightly higher than its specified value.

Note: The output over-voltage protection circuit senses the voltage across the output (pins 8 and 4) to determine when it should trigger, not the voltage across the converter's sense leads (pins 7 and 5). Therefore, the resistive drop on the board should be small enough so that output OVP does not trigger, even during load transients.

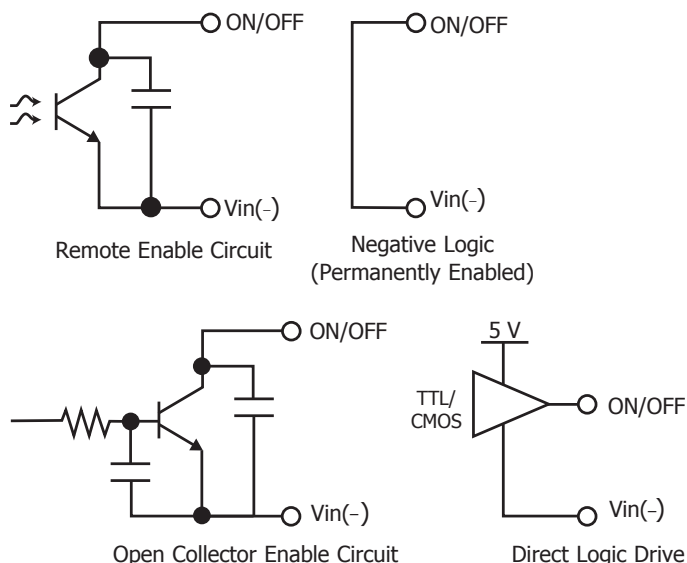

Figure A: Various circuits for driving the ON/OFF pin.

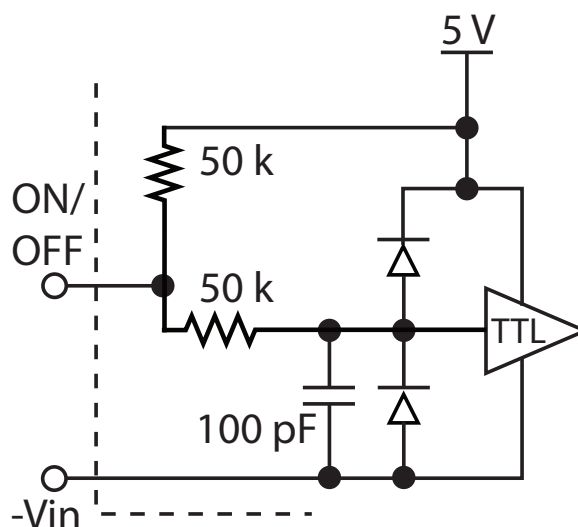

Figure B: Internal ON/OFF pin circuitry

**OUTPUT VOLTAGE TRIM (Pin 6):** The TRIM input permits the user to adjust the output voltage across the sense leads up or down according to the trim range specifications.

To decrease the output voltage, the user should connect a resistor between Pin 6 and Pin 5 (SENSE(-) input). For a desired decrease of the nominal output voltage, the value of the resistor should be:

$$R_{\text{trim-down}} = \left( \frac{511}{\Delta\%} \right) - 10.22 \text{ [k}\Omega\text{]}$$

where

$$\Delta\% = \left| \frac{V_{\text{nominal}} - V_{\text{desired}}}{V_{\text{nominal}}} \right| \times 100\%$$

To increase the output voltage, the user should connect a resistor between Pin 6 and Pin 7 (SENSE(+) input). For a desired increase of the nominal output voltage, the value of the resistor should be:

$$R_{\text{trim-up}} = \left( \frac{5.11V_{\text{OUT}} \times (100 + \Delta\%)}{1.225\Delta\%} - \frac{511}{\Delta\%} - 10.22 \right) \text{ [k}\Omega\text{]}$$

where  $V_{\text{OUT}}$  = Nominal Output Voltage

Trim graphs show the relationship between the trim resistor value and Rtrim-up and Rtrim-down, showing the total range the output voltage can be trimmed up or down.

Note: The TRIM feature does not affect the voltage at which the output over-voltage protection circuit is triggered. Trimming the output voltage too high may cause the over-voltage protection circuit to engage, particularly during transients.

It is not necessary for the user to add capacitance at the Trim pin. The node is internally filtered to eliminate noise.

**Total DC Variation of Vout:** For the converter to meet its full specifications, the maximum variation of the DC value of Vout, due to both trimming and remote load voltage drops, should not be greater than that specified for the output voltage trim range.

### Protection Features

**Input Under-Voltage Lockout:** The converter is designed to turn off when the input voltage is too low, helping to avoid an input system instability problem, which is described in more detail in the application note titled "Input System Instability" on [www.synqor.com](http://www.synqor.com). The lockout circuitry is a comparator with DC hysteresis. When the input voltage is rising, it must exceed the typical "Turn-On Voltage Threshold" value\* before the converter will turn on. Once the converter is on, the input voltage must fall below the typical Turn-Off Voltage Threshold value before the converter will turn off.

**Output Current Limit:** The maximum current limit remains constant as the output voltage drops. However, once the impedance of the load across the output is small enough to make the output voltage drop below the specified Output DC Current-Limit Shutdown Voltage, the converter turns off.

The converter then enters a "hiccup mode" where it repeatedly turns on and off at a 5 Hz (nominal) frequency with a 5% duty cycle until the short circuit condition is removed. This prevents excessive heating of the converter or the load board.

**Output Over-Voltage Limit:** If the voltage across the output pins exceeds the Output Over-Voltage Protection threshold, the converter will immediately stop switching. This prevents damage to the load circuit due to 1) excessive series resistance in output current path from converter output pins to sense point, 2) a release of a short-circuit condition, or 3) a release of a current limit condition. Load capacitance determines exactly how high the output voltage will rise in response to these conditions. After 200 ms the converter will automatically restart.

**Over-Temperature Shutdown:** A temperature sensor on the converter senses the average temperature of the module. The thermal shutdown circuit is designed to turn the converter off when the temperature at the sensed location reaches the "Over-Temperature Shutdown" value\*. It will allow the converter to turn on again when the temperature of the sensed location falls by the amount of the "Over-Temperature Shutdown Restart Hysteresis" value\*.

**Transient and Surge Protection:** The wide input range of the RailQor line of converters covers all transient requirements of EN 50155. For short duration transients and surges found in other standards (such as RIA 12) that exceed the maximum input voltage rating of the converter, SynQor has provided a design guide for a transient suppression circuit. Please consult the application note "RailQor EN 50155 / RIA-12 Compliance & Evaluation Board Application Note" on our website [www.synqor.com](http://www.synqor.com).

\* See Electrical Characteristics page.

#### APPLICATION CONSIDERATIONS

**Input System Instability:** This condition can occur because any DC-DC converter appears incrementally as a negative resistance load. A detailed application note titled "Input System Instability" is available on the SynQor website which provides an understanding of why this instability arises, and shows the preferred solution for correcting it.

**Application Circuits:** Figure C below provides a typical circuit diagram which details the input filtering and voltage trimming.

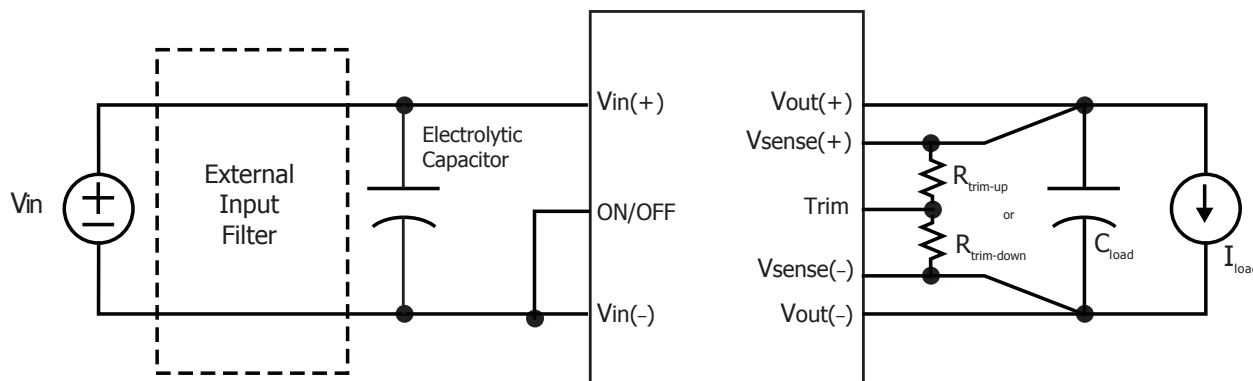

Figure C: Typical application circuit (negative logic unit, permanently enabled).

**Input Filtering and External Input Capacitance:** Figure D below shows the internal input filter components. This filter dramatically reduces input terminal ripple current, which otherwise could exceed the rating of an external electrolytic input capacitor.

The recommended external input capacitance is specified in the Input Characteristics section on the Electrical Specifications page. More detailed information is available in the application note titled "EMI Characteristics" on the SynQor website.

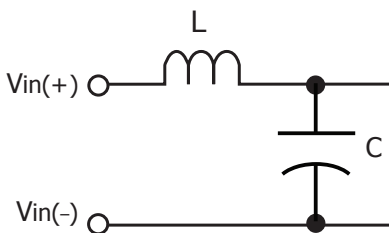

Figure D: Internal Input and Output Filter Diagram (component values listed on specifications page).

**Startup Inhibit Period:** The Startup Inhibit Period ensures that the converter will remain off for approximately 200 ms when it is shut down for any reason. When an output short is present, this generates a 5 Hz "hiccup mode," which prevents the converter from overheating. In all, there are six ways that the converter can be shut down, initiating a Startup Inhibit Period:

- Input Under-Voltage Lockout
- Output Over-Voltage Protection
- Over Temperature Shutdown
- Current Limit
- Short Circuit Protection
- Turned off by the ON/OFF input

Figure E shows three turn-on scenarios, where a Startup Inhibit Period is initiated at  $t_0$ ,  $t_1$ , and  $t_2$ :

Before time  $t_0$ , when the input voltage is below the UVL threshold, the unit is disabled by the Input Under-Voltage Lockout feature. When the input voltage rises above the UVL threshold, the Input Under-Voltage Lockout is released, and a Startup Inhibit Period is initiated. At the end of this delay, the ON/OFF pin is evaluated, and since it is active, the unit turns on.

At time  $t_1$ , the unit is disabled by the ON/OFF pin, and it cannot be enabled again until the Startup Inhibit Period has elapsed.

When the ON/OFF pin goes high after  $t_2$ , the Startup Inhibit Period has elapsed, and the output turns on within the typical Turn-On Time.

**Thermal Considerations:** The maximum operating baseplate temperature,  $T_{Bp}$  is 100 °C. As long as the user's thermal system keeps  $T_B < 100$  °C, the converter can deliver its full rated power.

A power derating curve can be calculated for any heatsink that is attached to the baseplate of the converter. It is only necessary to determine the thermal resistance,  $R_{TH-BA}$ , of the chosen heatsink between the baseplate and the ambient air for a given airflow rate. This information is usually available from the heatsink vendor. The following formula can be used to determine the maximum power the converter can dissipate for a given thermal condition if its baseplate is to be no higher than 100 °C.

$$P_{diss}^{max} = \frac{100 \text{ }^\circ\text{C} - T_A}{R_{TH-BA}}$$

This value of power dissipation can then be used in conjunction with the data shown in Figure 2 to determine the maximum load current (and power) that the converter can deliver in the given thermal condition.

For convenience, power derating curves for an encased converter without a heatsink are provided for each output voltage.

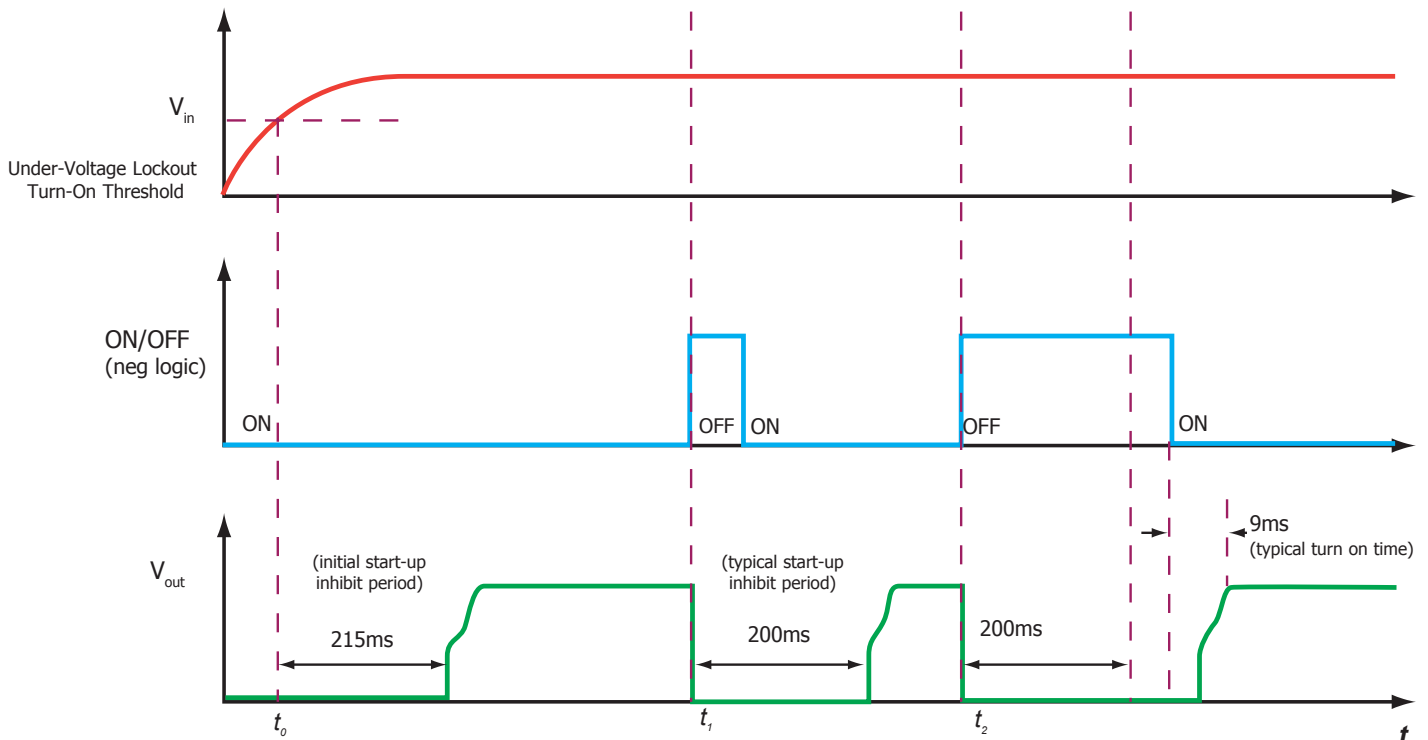

Figure E: Startup Inhibit Period (turn-on time not to scale)

**Designing for Maximizing Available Power:** RailQor products have been designed for full power operation in demanding thermal environments. However, there are techniques that can be applied external to the converter to ensure the best possible thermal performance. These include correctly applying a heatsink to the baseplate of the converter and maximizing the heat transferred through the pins. The following discussions are only guidelines and may not be necessary depending on the application

**Optimal Heatsink Application:** There are two key components to maximizing the thermal dissipation when using a heatsink. One is minimizing the thermal resistance between the converter and the heatsink itself. There are imperfections between the mating surfaces that reduce contact area between the two. A suitable thermally conductive interface material should be used to maintain a good thermal connection. A commonly used example is thermal grease. When utilizing the threaded inserts on the baseplate of a SynQor converter, care must be taken not to exceed the torque or screw depth guidelines found in the mechanical diagram. Two, airflow must be directed to pass between the fins of the heatsink to maximize the surface area for heat removal.

Heatsinks are often available with both transverse and longitudinal fin direction to allow system flexibility. Care should be taken to avoid large external components surrounding the converter from blocking airflow.

**Layout Considerations:** Significant performance improvement can be made by designing a printed circuit board to properly sink heat away from the converter through its pins. The first step is to ensure a correctly formed solder joint at each pin. A smooth fillet and complete barrel fill should be observed at the boundary of pin and mounting hole to ensure maximum heat conduction from pin to board (Figure F). It is worth noting here that encased SynQor products are not compatible with reflow processes as it may disrupt the placement of internal components.

The board itself should also have as many layers and as high of copper weight as is practical for the application. Large ground and power planes are best as the most heat will be conducted through the large power pins of the converter on both input and output sides. The heat must also have a path to conduct from the copper planes of the board to the outside environment. The typical FR4 material used in construction of a printed circuit board is greater than 1000 times less thermally conductive than copper and will act as an insulator between each copper plane. To mitigate this, generous use of thermal vias is recommended in the board area surrounding and below the converter. A proper density of vias allows heat to conduct from the board to the air while maintaining a large amount of copper area to conduct to the vias. For reference, boards used in SynQor thermal testing are 6 layer, 2 oz. copper boards with 50 mil diameter thermal vias at a density of 36/in<sup>2</sup> (Figure G).

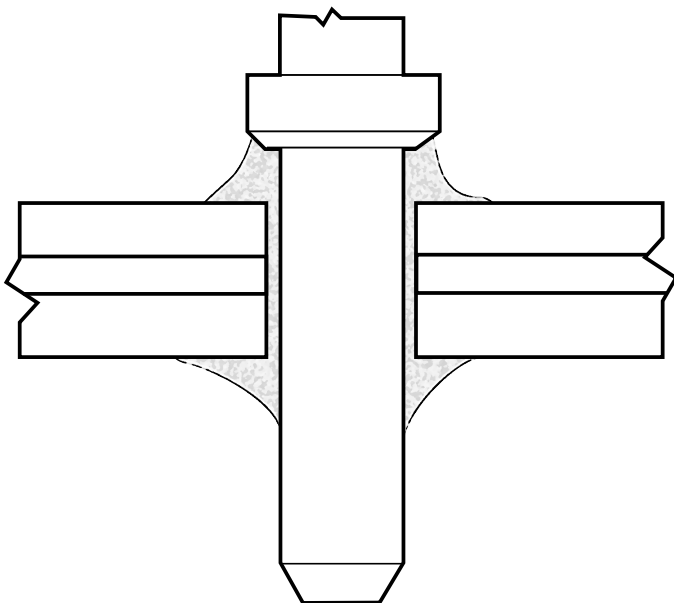

Figure F: Example of properly soldered pin joint

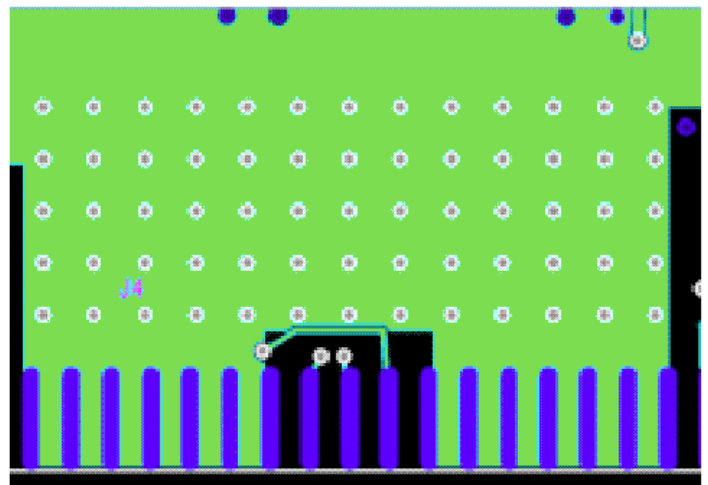
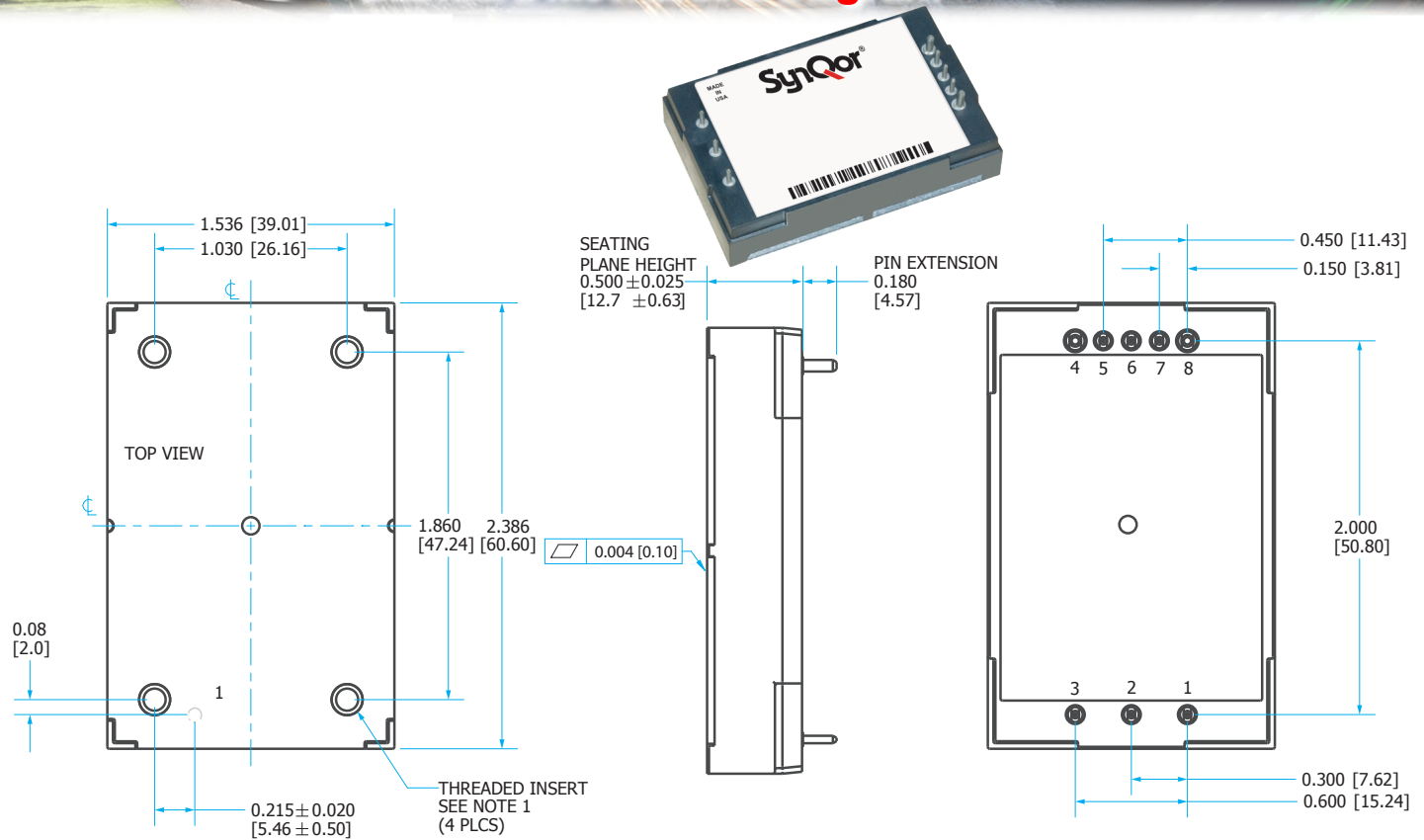

Figure G: Image of thermal via layout surrounding converter in test board



### Standard Mechanical Diagram



#### NOTES

- M3 screws used to bolt unit's baseplate to other surfaces (such as a heatsink) must not exceed 0.100" (2.54 mm) depth below the surface of the baseplate.
- Applied torque per screw should not exceed 6in-lb. (0.7 Nm).
- Baseplate flatness tolerance is 0.004" (.10mm) TIR for surface.
- Pins 1-3, 5-7 are 0.040" (1.02mm) diameter, with 0.080" (2.03mm) diameter standoff shoulders.
- Pins 4 and 8 are 0.062" (1.57 mm) diameter with 0.100" (2.54 mm) diameter standoff shoulders.
- All Pins: Material - Copper Alloy- Finish (RoHS 6/6)  
- Matte Tin over Nickel plate
- Weight: 2.9 oz. (84 g) typical
- Workmanship: Meets or exceeds IPC-A-610 Class II
- All dimensions in inches (mm)  
Tolerances: x.xx +/-0.02 in. (x.x +/-0.5mm)  
x.xxx +/-0.010 in. (x.xx +/-0.25mm)

#### PIN DESIGNATIONS

Pin	Label	Name	Function
1	+VIN	Vin(+)	Positive input voltage
2	ON/OFF	ON/OFF	TTL input to turn converter on and off, referenced to Vin(-), with internal pull up.
3	IN RTN	Vin(-)	Negative input voltage
4	OUT RTN	Vout(-)	Negative output voltage
5	-SNS	SENSE(-)	Negative remote sense (See note 1)
6	TRIM	TRIM	Output voltage trim (See note 2)
7	+SNS	SENSE(+)	Positive remote sense (See note 3)
8	+VOUT	Vout(+)	Positive output voltage

#### Notes:

- SENSE(-) should be connected to Vout(-) either remotely or at the converter.
- Leave TRIM pin open for nominal output voltage.
- SENSE(+) should be connected to Vout(+) either remotely or at the converter.

### Flanged Mechanical Diagram

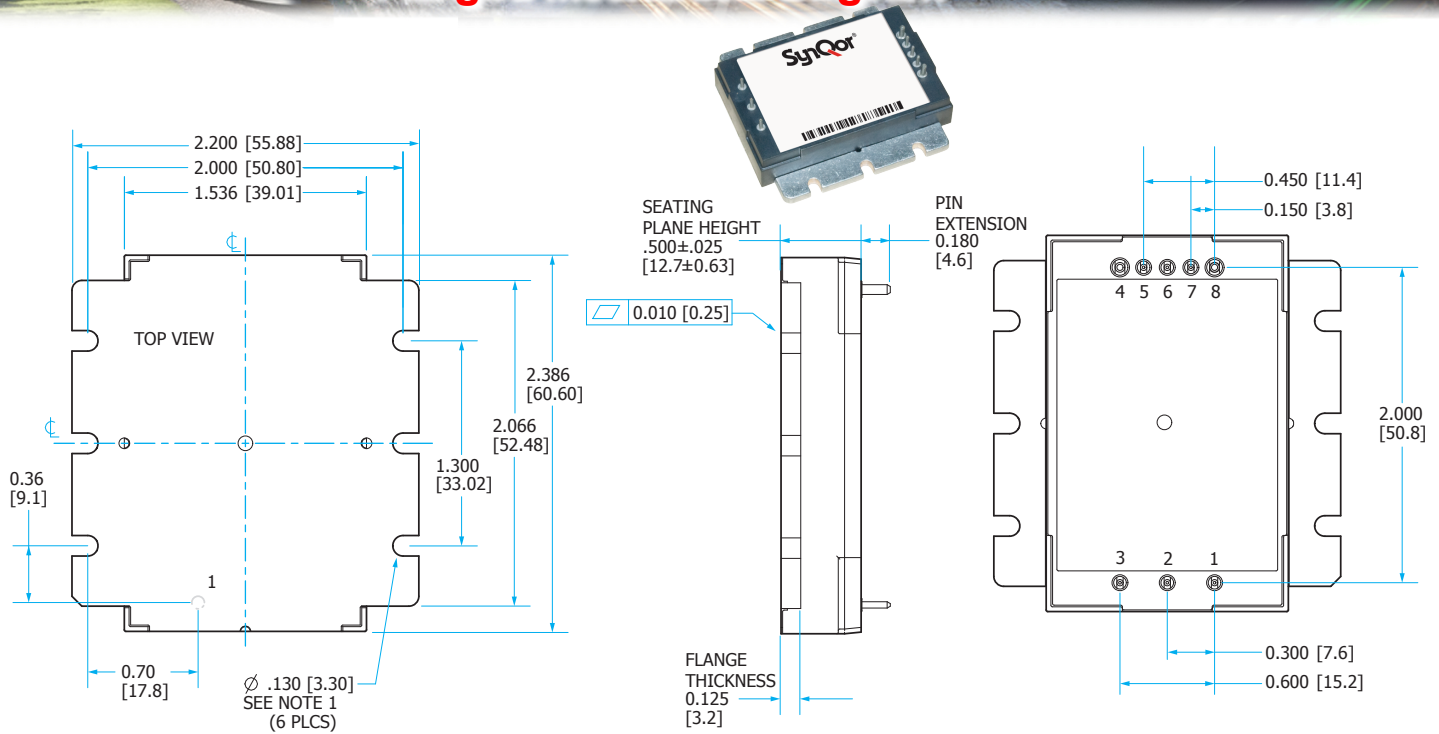

#### NOTES

- Applied torque per screw should not exceed 6in-lb. (0.7 Nm).
- Baseplate flatness tolerance is 0.01" (.2mm) TIR for surface.
- Pins 1-3, 5-7 are 0.040" (1.02mm) diameter, with 0.080" (2.03mm) diameter standoff shoulders.
- Pins 4 and 8 are 0.062" (1.57 mm) diameter with 0.100" (2.54 mm) diameter standoff shoulders.
- All Pins: Material - Copper Alloy, Finish (RoHS 6/6) - Matte Tin over Nickel plate
- Weight: 3.2 oz (90 g) typical
- Workmanship: Meets or exceeds IPC-A-610 Class II
- All dimensions in inches (mm)  
Tolerances: x.xx +/-0.02 in. (x.x +/-0.5mm)  
x.xxx +/-0.010 in. (x.xx +/-0.25mm)

#### PIN DESIGNATIONS

Pin	Label	Name	Function
1	+VIN	Vin(+)	Positive input voltage
2	ON/OFF	ON/OFF	TTL input to turn converter on and off, referenced to Vin(-), with internal pull up.
3	IN RTN	Vin(-)	Negative input voltage
4	OUT RTN	Vout(-)	Negative output voltage
5	-SNS	SENSE(-)	Negative remote sense (See note 1)
6	TRIM	TRIM	Output voltage trim (See note 2)
7	+SNS	SENSE(+)	Positive remote sense (See note 3)
8	+VOUT	Vout(+)	Positive output voltage

#### Notes:

- SENSE(-) should be connected to Vout(-) either remotely or at the converter.
- Leave TRIM pin open for nominal output voltage.
- SENSE(+) should be connected to Vout(+) either remotely or at the converter.

## STANDARDS COMPLIANCE

Parameter	Notes & Conditions
<b>STANDARDS COMPLIANCE</b>	

EN 60950-1	Reinforced insulation
UL 60950-1	
CAN/CSA C22.2 No. 60950-1	

Note: An external input fuse must always be used to meet these safety requirements. Contact SynQor for official safety certificates on new releases or download from the SynQor website.

## QUALIFICATION TESTING

Parameter	# Units	Test Conditions
<b>QUALIFICATION TESTING</b>		

Vibration	5	EN 61373:1999 Category I, Class B, Body mounted
Life Test	30	95% rated Vin and load, units at derating point, 1000 hours
Cold	5	EN 60068-2-1:2007
Dry Heat	5	EN 60068-2-2:2007
Mechanical Shock	5	EN 61373:1999 Category I, Class B, Body mounted
Temperature Cycling	5	-40 °C to 100 °C, unit temp. ramp 15 °C/min., 500 cycles
Power/Thermal Cycling	5	Toperating = min to max, Vin = min to max, full load, 100 cycles
Design Marginality	5	Tmin-10 °C to Tmax+10 °C, 5 °C steps, Vin = min to max, 0-105% load
Damp Heat, Cyclic	5	EN 60068-2-30:2005
Solderability	15 pins	MIL-STD-883, method 2003.8

Note: Governing Standard BS EN 50155:2007 Railway applications - Electronic equipment used on rolling stock

## PART NUMBERING SYSTEM

The part numbering system for SynQor's dc-dc converters follows the format shown in the example below.

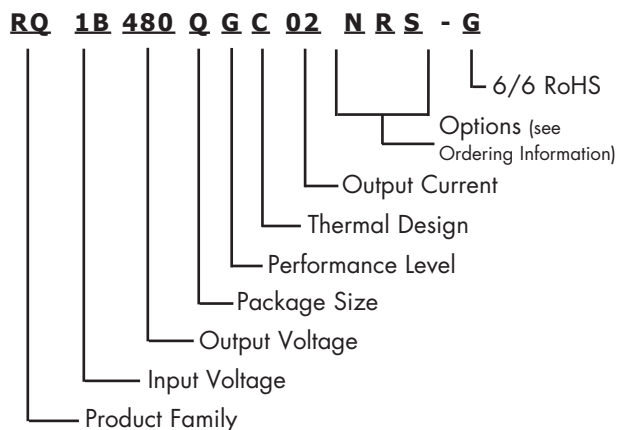

The first 12 characters comprise the base part number and the last 3 characters indicate available options. The "-G" suffix indicates 6/6 RoHS compliance.

## Application Notes

A variety of application notes and technical white papers can be downloaded in pdf format from our [website](#).

**RoHS Compliance:** The EU led RoHS (Restriction of Hazardous Substances) Directive bans the use of Lead, Cadmium, Hexavalent Chromium, Mercury, Polybrominated Biphenyls (PBB), and Polybrominated Diphenyl Ether (PBDE) in Electrical and Electronic Equipment. This SynQor product is 6/6 RoHS compliant. For more information please refer to SynQor's RoHS addendum available at our [RoHS Compliance / Lead Free Initiative web page](#) or e-mail us at [rohs@synqor.com](mailto:rohs@synqor.com).

## ORDERING INFORMATION

The tables below show the valid model numbers and ordering options for converters in this product family. When ordering SynQor converters, please ensure that you use the complete 15 character part number consisting of the 12 character base part number and the additional characters for options. Add "-G" to the model number for 6/6 RoHS compliance.

Model Number	Input Voltage	Output Voltage	Max Output Current
RQ1B050QGw20xyz-G	66-160 V	5 V	20 A
RQ1B120QGw08xyz-G	66-160 V	12 V	8.4 A
RQ1B240QGw04xyz-G	66-160 V	24 V	4.2 A
RQ1B480QGw02xyz-G	66-160 V	48 V	2.1 A

The following options must be included in place of the **wxyz** spaces in the model numbers listed above. Not all combinations make valid part numbers, please contact SynQor for availability.

Thermal Design w	Enable Logic x	Pin Style y	Feature Set z
C - Encased V - Encased with Flanged Baseplate	N - Negative	R - 0.180"	S - Standard

## Contact SynQor for further information and to order:

**Phone:** 978-849-0600  
**Toll Free:** 888-567-9596  
**Fax:** 978-849-0602  
**E-mail:** [power@synqor.com](mailto:power@synqor.com)  
**Web:** [www.synqor.com](http://www.synqor.com)  
**Address:** 155 Swanson Road  
 Boxborough, MA 01719  
 USA

## PATENTS

SynQor holds numerous U.S. patents, one or more of which apply to most of its power conversion products. Any that apply to the product(s) listed in this document are identified by markings on the product(s) or on internal components of the product(s) in accordance with U.S. patent laws. SynQor's patents include the following:

6,545,890 6,594,159 6,894,468 6,896,526 6,927,987 7,050,309  
 7,085,146 7,119,524 7,765,687 7,787,261 8,149,597 8,644,027

## WARRANTY

SynQor offers a two (2) year limited warranty. Complete warranty information is listed on our website or is available upon request from SynQor.